

Products	10.0
Products	10.1
Products	10.2
Load details for Bolts, Threaded Rods, Threaded Tube	10.3
Basics for heavy duty fixings	10.4
Basics for heavy duty fixings	10.5
Installation instructions Drive Plug AN and Bolt Anchor AN BZ PLUS	10.6
Installation of Resin Anchor System	10.7
Installation Instructions Hollow Core Anchor Bolt	10.8



Products

Bolt Anchor AN BZ PLUS



Drive Plug AN ES

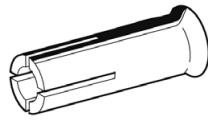

Setting Tool for Drive Plug ANT



**Resin Anchor Rod VMZ-A
Resin Anchor Rod VMU-A**

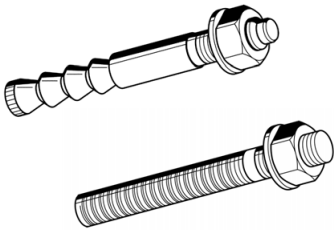

**Resin Injection Cartridge VMZ
345; VMU; VM-K / Perforated
Sleeve SH**

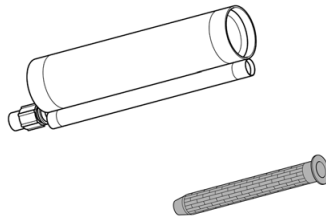

Assessories VMZ; VMU; VM-K

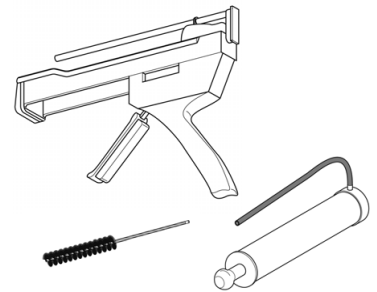

Dispenser; Steel brush; Blow-out Pump

Screwbolt MMS-ST

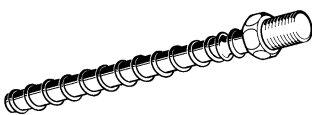

**Screwbolt MMS-PR
Screwbolt MMS-I**

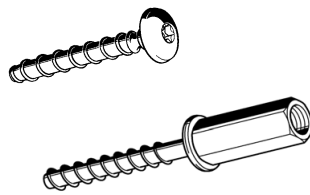

Hollow Core Anchor AN Easy

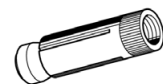

Nail Anchor PN 27

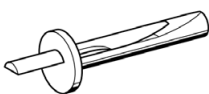

Setting Tool PN



Nylon Plug AN

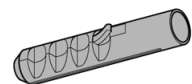

Products

Rod Coupling AD f/f

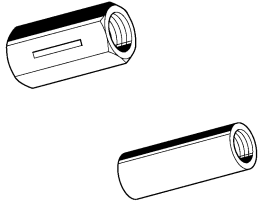

IG/IG; round

Reducer AD f/m

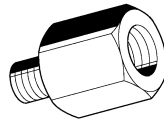

Reducer AD m/f

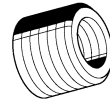

Eye Bolt SCR



Flat Leaf Bolt SCR

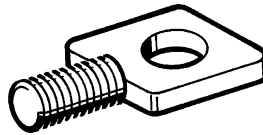

Link Eye SCB



**Eye Screw SCR
Eye Screw C RIN C**

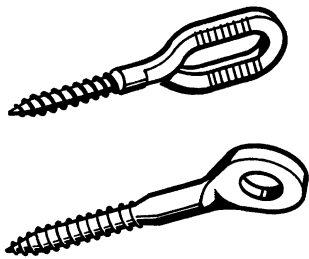

Twin Holder DHP M8

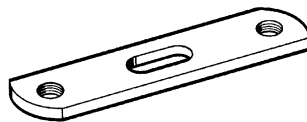

Threaded Spacer BOL M8



Hexagon Wood Screw SKH

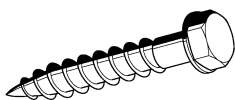

Slotted Screw SCR

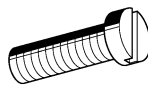

Hexagon Bolt SKT

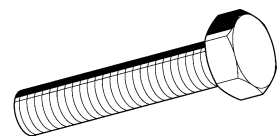

Products

Hexagon Nut NT

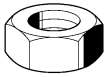

Flange Nut NT FLA

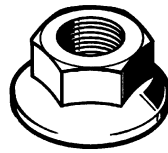

Threaded Rod GST
Threaded Stud GST

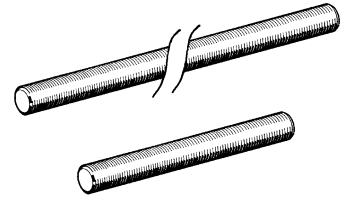

Locking Nut NT G

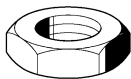

Threaded Tube GR

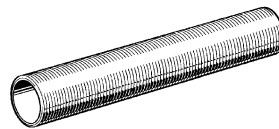

Grooved Rod GES PNS

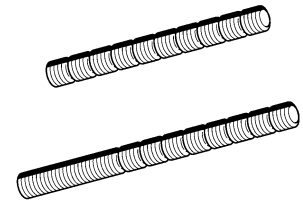

Bolt Screw BSCR with collar

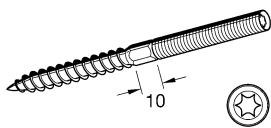

Hexagon Socket Screw SCR

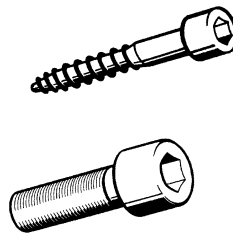

Washer US



Bolt Screw BSCR without collar

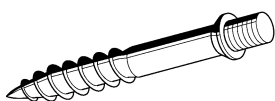

Flange Screw FLA HCP

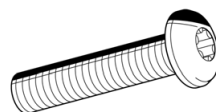

Bolt Screw Adapter ANT BIT

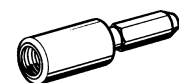

Load details for Bolts, Threaded Rods, Threaded Tube

Bolts and Threaded Rods

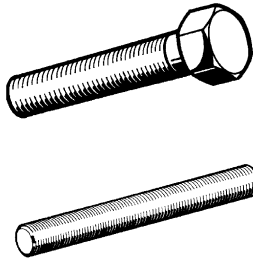

FK = Grade
 $\mu_{ges} = 0.14$

$\sigma_{adm} \leq 215 \text{ N/mm}^2$ (FK 4.8)
 $f_{adm} \leq 3 \text{ mm}$

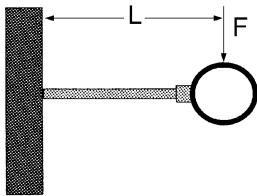

Thread	Permissible Load (tension) [kN]			Torque [Nm]	
	FK 4.8	FK 8.8	VA	FK 4.8	FK 8.8
M 8	8.0	15.6	4.6	12	25
M10	12.5	24.7	7.4	23	50
M12	18.1	35.9	10.8	40	85
M16	33.8	66.7	20.0	100	210

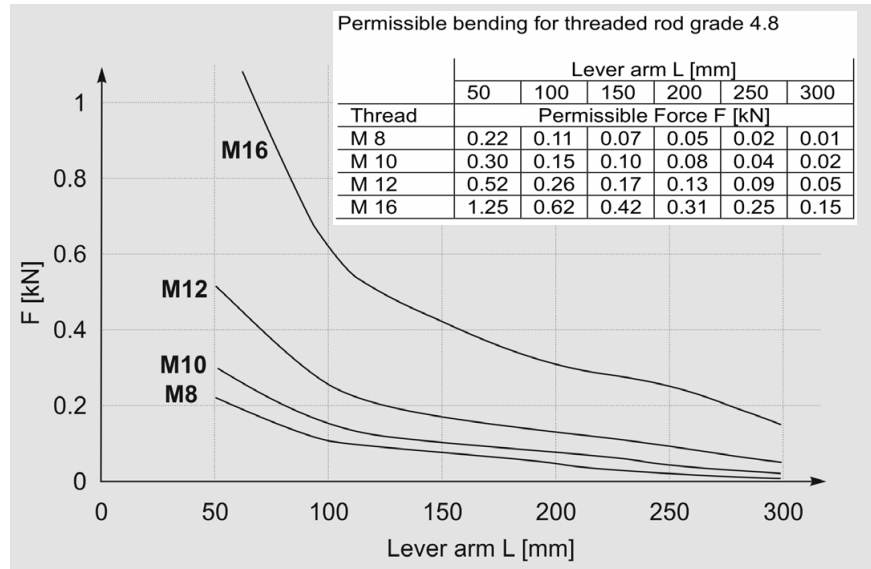

Threaded Tube

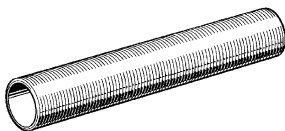

Thread acc. to DIN ISO 228

$\sigma_{adm} \leq 160 \text{ N/mm}^2$
 $f_{adm} \leq 3 \text{ mm}$

Anchor loads have to be calculated separately.

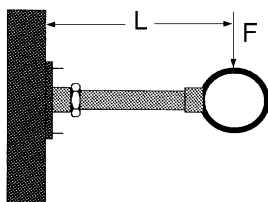

Thread	Permissible Load (tension) [kN]	Permissible Bending Moment [Nm]
G 1/2	18.0	53
G 3/4	28.3	138
G 1	41.4	277

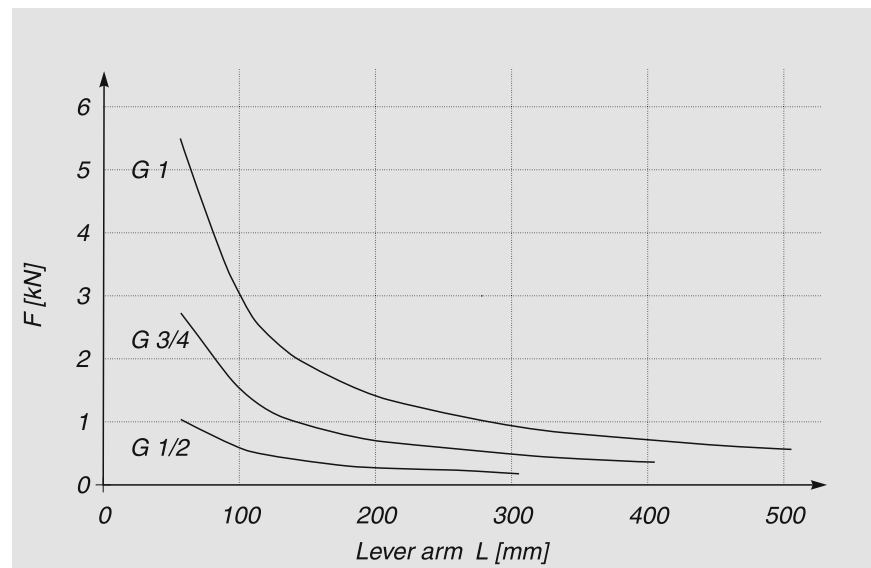

Basics for heavy duty fixings

Tensile zone (cracked concrete)

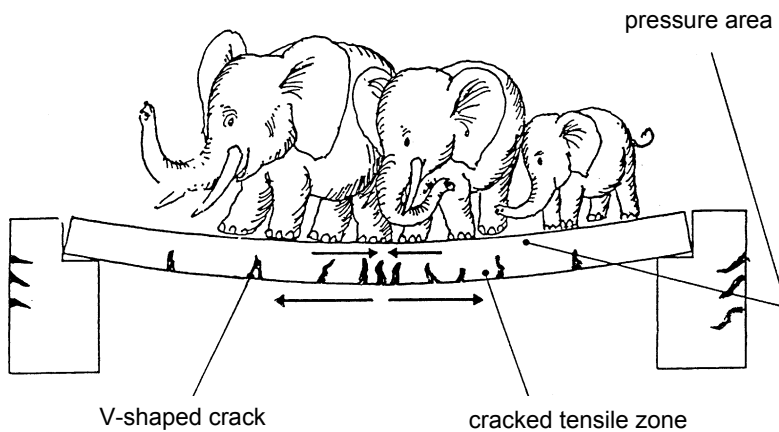

The crack width usually is approx. 0.3 ... 0.5 mm.

[Source: fischerwerke]

Tensile stress can cause cracks in all concrete parts of a building.

Areas particularly affected by tensile stress include the underside of slabs, and walls / columns under bending stresses.

Unless proven as a compression zone, all areas of concrete into which fixings and anchors are installed must be considered as cracked concrete.

Approvals

Anchors must be dimensioned and calculated according to European Approvals (**ETA**). The guidelines for these approvals are known as ETAGs and often statements on the characteristic load resistance of fixings to cracked concrete in the case of fire, can also be found here.

Function of Fixings

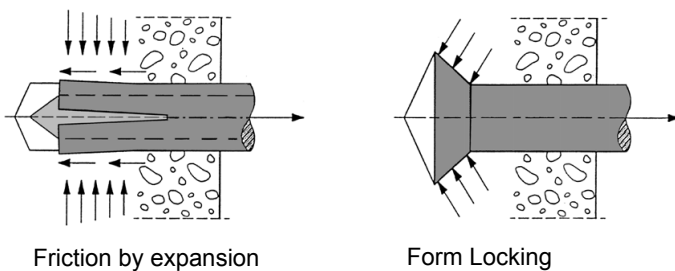

Anchors in cracked concrete have additional security through;

- automatic secondary expansion in case of crack expansion
- form locking by an undercut drill hole

Types of installation

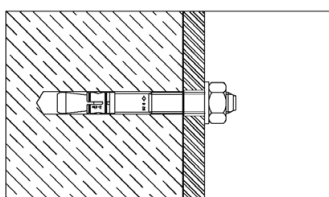

Push-through installation
(Bolt Anchor)

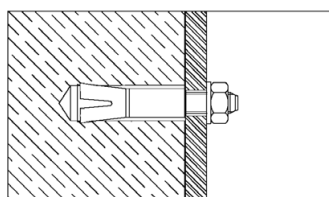

Pre-positioned installation
(internal thread anchor)

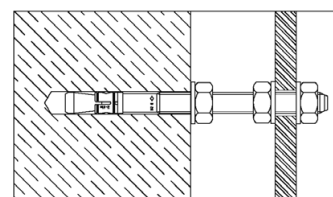

Stand-off installation
(Bolt Anchor)

[Source: MKT]

Basics for heavy duty fixings

Axial spacing, edge distance, pull-out cone

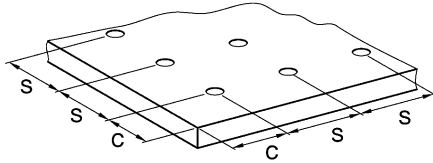

- s = Axial spacing > red s = reduced axial spacing (in case of partial overlap of theoretical pull-out cones)
- c = Edge distance
- h = Component thickness
- F_z = permissible loading (also N = normal force)

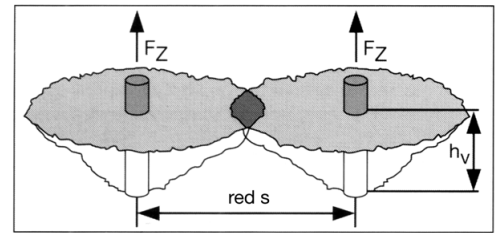
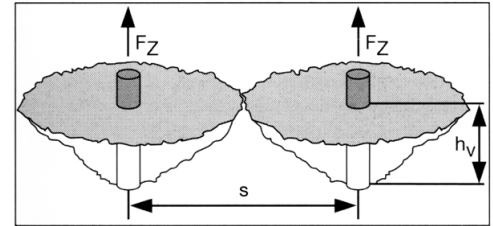
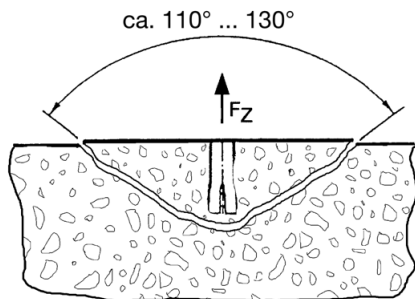

In the event of "concrete cone failure", a symmetrical cone of the concrete breaks away. The anchor depth h_v is therefore a determining factor in the load capacity.

Types of loading

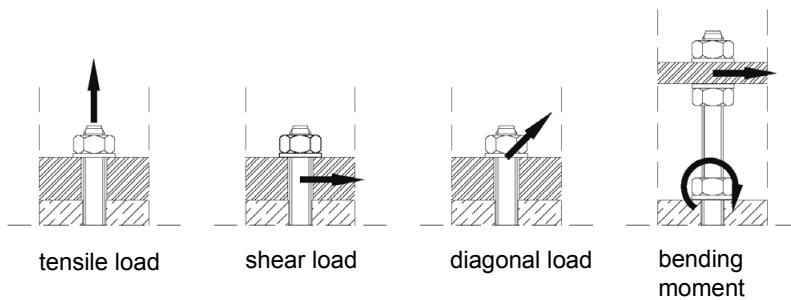

Basic rules for anchorages

- ① Load capacity: Anchor type, base material strength and drill hole positions typically determine the load resistance of the anchorage.
- ② Concrete tensile area: The load values often refer to the anchor performance in a concrete base material of class C20/25 (formerly B25).
- ③ Corrosion protection: Electro-galvanised anchors are typically only used only for dry indoor environments. For damp environments and outdoors, anchors hot dip galvanised or made of stainless steel are typically specified.
- ④ Fire protection: According to TRGI, the anchors for gas pipes must be manufactured from non-combustible steel; equally for fire protection of fixings according to comments from MLAR.



Anchors for multiple use in non-structural applications

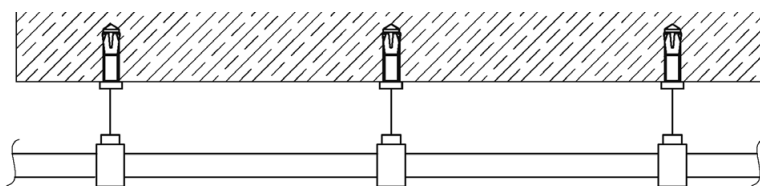

According to ETAG - part 6, a multiple fixing is existant when a pipeline has at least 3 fixings and the loading per point is max. 2 kN.
ETAG = Guide line for European Technical Approvals (ETA)

Installation instructions Drive Plug AN and Bolt Anchor AN BZ PLUS

Drive Plug AN ES

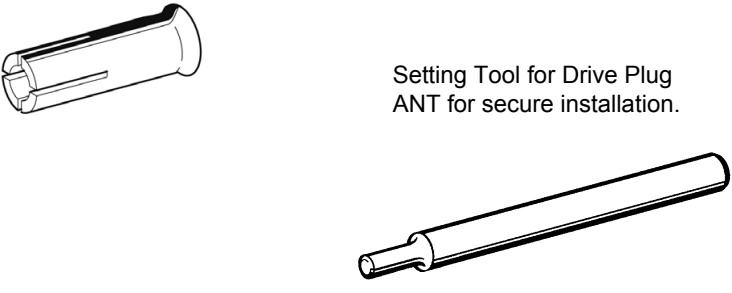

Setting Tool for Drive Plug AN T for secure installation.

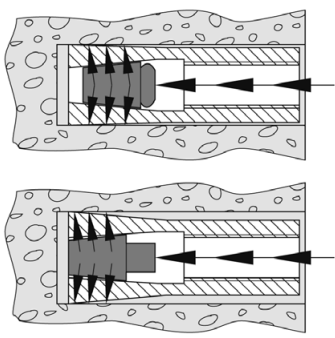

Independent of small diameter tolerances of the drillhole, the "intelligent" expanding cone simplifies installation by always developing the right pressure.

European Approvals (ETA) for multiple fixings used in non-structural systems in cracked concrete.

Load capacity is reduced in considering performance under exposure to fire.

Advantages

- no special drill bit
- low impact energy when setting fixing
- suitable for pre-positioned installation.

Installation

- 1) Drill hole
- 2) Clean out the drilled hole
- 3) Set Drive Plug AN ES with Setting Tool ANT
- 4) Place installation item and connect to Drive Plug AN ES with correct length of threaded bolt or stud, and tightening torque.

Bolt Anchor AN BZ PLUS

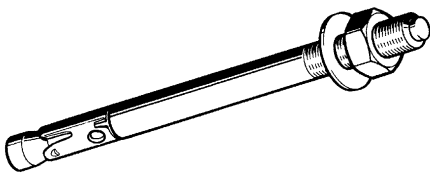

Identical drill hole diameter to thread size

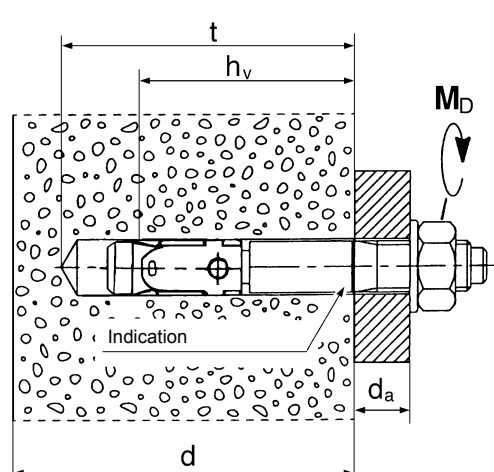

d = Thickness of components
 d_a = Thickness of attachment parts
 h_v = Anchor depth
 M_D = specified tightening torque
 t = Depth of drill hole

European Approvals (ETA) for multiple fixings used in non-structural systems in cracked concrete.

Load capacity is reduced in considering performance under exposure to fire.

Advantages

- no special drill bit
- low impact energy when setting fixing
- suitable for pre-positioned installation.

Installation

- 1) Drill hole
- 2) Clean out the drilled hole
- 3) Set Drive Plug AN ES with Setting Tool ANT
- 4) Place installation item and connect to Drive Plug AN ES with correct length of threaded bolt or stud, and tightening torque.

Installation of Resin Anchor System

Injection system VMZ

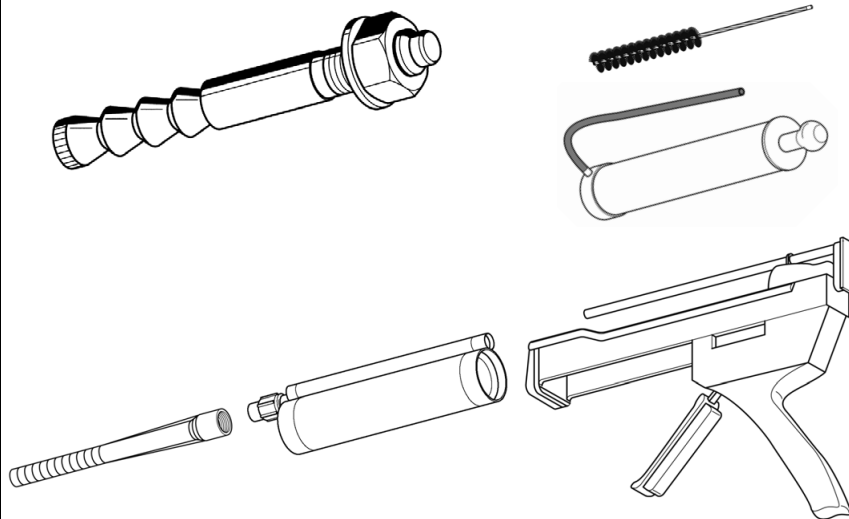

Resin and hardener are mixed together in the mixer nozzle during dispensing from the cartridge. From the bottom depth of the drill hole, inject the resin to fill a minimum of 2/3rds of the hole.

European Approvals (ETA) for multiple fixings used in non-structural systems in cracked concrete.

Load capacity is reduced in considering performance under exposure to fire.

Advantages

- no special drill bit
- unabated carrying capacity in wet drill holes
- processing from M12 on, even in water-filled drill hole
- processing temperature up to -5°C
- High load capacity with small edge distances and axial spacings

Installation

- 1) Drill hole
- 2) Brush out debris from the drilled hole
- 3) Blow out dust from the drilled hole
- 4) Fill the injection resin to the drilled hole
- 5) Screw in the anchor rod to the correct depth within the resin-filled hole
- 6) Allow resin to cure for the correct time (according to ambient installation temperature on site)
- 7) Affix connecting part and tighten down nut to specified torque.

Injection System VMU

Resin anchor stud VMU and perforated sleeve SH to be used in hollow or perforated brick

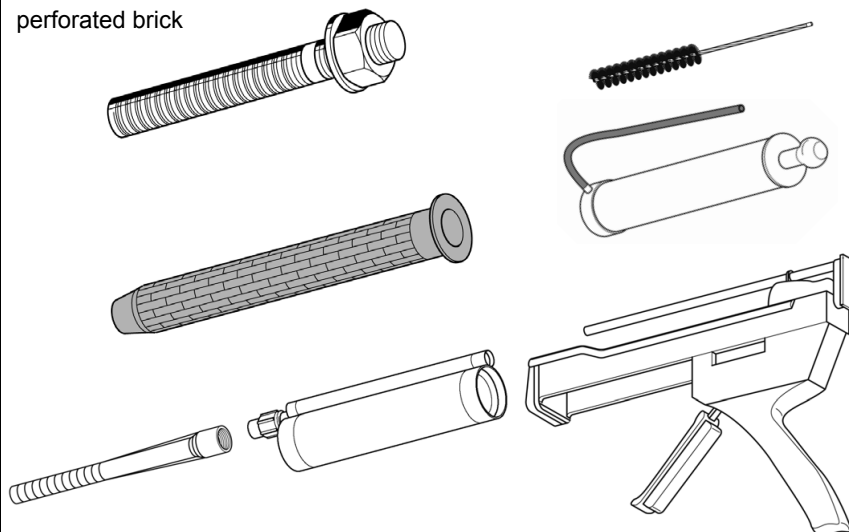

Suitable for brickwork (solid brick, sand-lime brick) and in combination with the Perforated Sleeve SH for:

- vertically perforated brick
- perforated sand-lime brick
- hollow brick made of gas concrete and concrete.

European Approval (ETA) for single fixation in uncracked concrete, general building inspection approval for anchorage in brickwork

Advantages

- no special drill bit
- Fixings possible to wet drill holes
- High load capacity with relatively small edge distances and axial spacings.

Installation

- 1) Drill hole
- 2) Brush out debris from the drilled hole
- 3) Blow out dust from the drilled hole
- 4) Install the perforated sleeve to the drilled hole (recommended for perforated brick)
- 5) Fill the injection resin to the perforated sleeve (100% fill)
- 6) Screw in the anchor rod to the correct depth within the resin-filled sleeve
- 7) Allow resin to cure for the correct time (according to ambient installation temperature on site)
- 8) Affix connecting part and tighten down nut to specified torque.



Installation Instructions Hollow Core Anchor Bolt

Hollow core anchor AN Easy

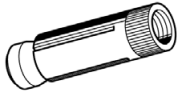

The anchor could be used, even if the bracing area is not inside the hollow chamber.

When tightening the screw, the conus is released from the anchor sleeve, roped in and tensed up

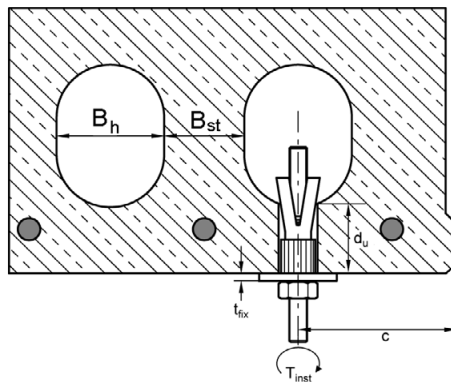

$$B_h \leq 4.2 * B_{st}$$

General building inspection approval of the DIBt for single fixation in prestressed concrete-hollow ceilings with stability $\geq C 45/55$.

Considering reduced resilience suitable for exposure to fire.

Advantages

- no special drill needed
- suitable for the assembly of standard bolts and threaded rods

Installation

- 1) Drill the bore hole
- 2) Drive in anchor flushy
- 3) After tightening to specified torque, directly resilient.

Screwbolt MMS-ST

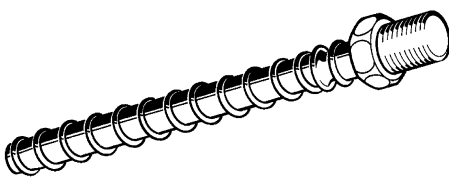

Suitable for installation to concrete and masonry (sand-lime brick, solid brick, clinker and natural stone)

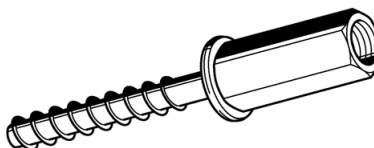

combined internal thread socket M8/M10

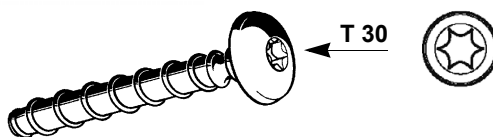

T 30

Screwbolt MMS-PR

ideal for the installation of Channel 27 to concrete and masonry Torx® -Connection T30 for a safe transfer of high torque during installation.

The screwbolt may be adjusted and is also removable.

European approval (ETA) for single fixation in cracked concrete for size 10 from 65 mm anchorage depth.

DIBt-Approval for the installation of lightweight suspended ceilings and comparable systems in cracked concrete for size 7.5.

Load capacity is reduced in considering performance under exposure to fire.

Advantages

- minimal drilling effort (small diameter and short embedment depths)
- small edge and axial spacings possible
- removable fixing

Installation

- 1) Drill the hole
- 2) Clean the drilled hole
- 3) Install with screw gun or impact driver.

